



ACO ShowerDrain

Premium Catalog





Shower Drains Designed to Impress

ACO ShowerDrain Premium bathroom drainage solutions inspire creative bathroom planning. Linear ShowerChannels and ShowerPoint area drains are suitable for traditional curb shower design or allow for the elimination of physical barriers within the bathroom floor for a more contemporary look or to comply with universal design concepts.

Contents

1 Premium ShowerChannel

Features & Benefits	04
Finishes	06
Grate Designs	
Flag	08
Hawaii	10
Linear	12
Mix	14
Piano	16
Quadrato	18
Solid	20
Tile-In	22
Wave	24
Channel Options	
Plain Edge	28
Weeping Flange Edge	30
Flange Edge	30
Custom Solutions	32

2 Premium ShowerPoint

Hawaii	34
Mix	34
Quadrato	34
Wave	34
Tile-In	35
ShowerPoint	
Drain Body Options	36

3 Accessories

PVC Drain Flange	37
Cast Iron Drain Flange	37
Stainless Steel Clad Coupling	37
Debris Stainer	37

4 Technical Information

Premium ShowerChannel	38
Premium ShowerPoint	40

5 Premium Grate Visualizer

Premium Grate Visualizer	42
--------------------------	----

6 askACO

askACO	43
--------	----

Premium

ShowerChannel Features & Benefits



Stainless steel (Grade 304) channels available in seven standard lengths, from 27.5" (700 mm) to 59.05" (1500 mm).

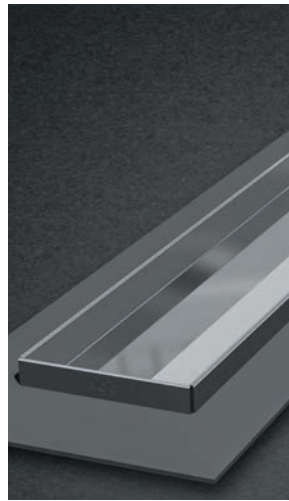

Shower channel body to suit either CPE shower membrane, fabric membrane or hot-mopped painted membrane. Flange edge channel with factory-fitted, waterproof, fabric membrane also available.



Centrally located 2.0" (51 mm) stainless steel spigot outlet with optional debris strainer. Vertical and offset outlets within the channels are also available.

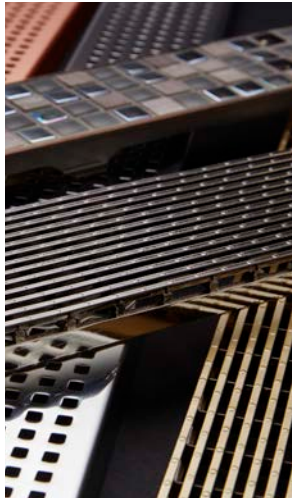

Variety of 16 gauge - 0.06" (1.5 mm) stainless steel designer grates in all standard lengths with nylon alignment studs in the ends (except Tile-In, Solid, Glass, & Linear), providing friction-fit locking. Lifting key provides easy removal.



Stainless steel grates available in seven new, unique finishes that complement a wide variety of bathroom fixtures.

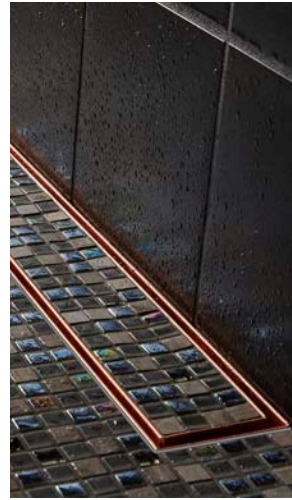

Discreet tile-in grate available to provide a subtle drain to match your flooring.

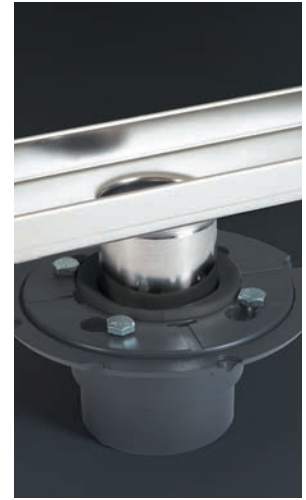

Pipe connection options include a drain flange or compression gasket. Adjustable plastic feet are included to support the channel during installation.

Premium

Finishes

Enhance your space with one of our most flattering and timeless finishes. These popular options are available on-demand which ensures faster delivery to you. Choose a classic finish that will complement and complete your shower to enjoy for years to come.

CLASSIC FINISH



Brushed Stainless

ACO's Brushed Stainless finish (formerly Electropolished) captures a classic 'brush-stroke' texture. A modern, yet timeless finish that pairs well together with almost anything, especially with Brushed Nickel and most silver-toned metals and hardware.

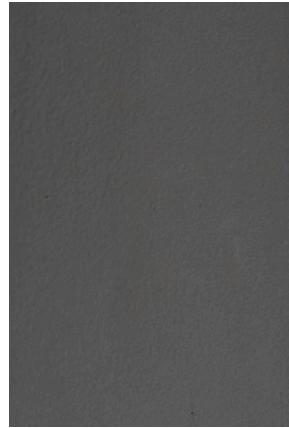

Matte Black

Our highly popular, Matte Black finish will create a grand and prestigious feel in your space. It offers a flat black finish without shine or reflection. Offering an edgy, minimal but stylish finish with a trendsetting sheen that pairs well with many various colors and hues.

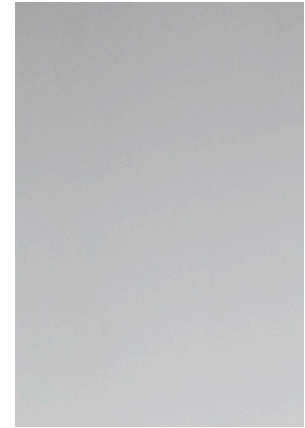

Polished Chrome

Our Polished Chrome features a mirror-like finish and appears reflective, adding a touch of modernism. Though not actually chrome plated to ensure longevity, this finish pairs well with most cool-hue hardware to create a lustrous balance.

Explore specially curated, hand-crafted finishes made just for you. Unique colors that respond to modern trends beautifully and stand out from the crowd. These made-to-order luxury finishes create drama and stunning trend-setting combinations that you will love.

LUXURY FINISH

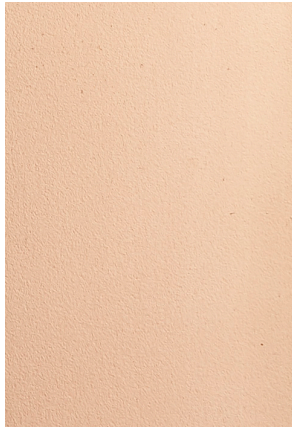

Rose Gold

Delicate, lustrous blend of yellow gold, copper and silver shades to produce a subtle romantic finish. A modern look that flatters and creates a stunning combination that pairs with most Rose Gold, Pink or Copper finishes on the market.



Oil-Rubbed Bronze

Created to mimic natural aging and weathering of pure bronze, our Oil-Rubbed Bronze finish is handcrafted to evoke uniqueness and create an antique ambiance. Featuring a darker earth-tone hue that pairs well with other warm and neutral colors.



Satin Brass

A striking allure of warmth is achieved through golden hues seamlessly blended and showcased in a satin finish. Explore a rich and vivid look that stands-out in just the right way. This finish enhances most yellow and gold tones and pairs well with darker colors.



Black Nickel

Luminous and moody, much like a full-moon, Black Nickel is a contemporary dark yet reflective shade used to convey strength and style. Create a unique and dramatic look with this finish that can be combined with most Titanium and black stainless tones.

Flag



SLOT SIZE
0.28" (7 mm) max width

Brushed Stainless



**Brushed
Stainless**

CLASSIC FINISH

Part No.	LENGTH in (mm)	GRATE INTAKE sq in (sq cm)
37369	27.55 (700)	21.33 (137.7)
37370	31.50 (800)	25.10 (162.0)
37371	35.43 (900)	28.85 (186.2)
37372	39.37 (1000)	31.36 (202.4)
37373	47.25 (1200)	36.37 (234.7)
37417	55.12 (1400)	41.38 (267.0)
37378	59.05 (1500)	45.05 (290.6)



**Polished
Chrome**

CLASSIC FINISH

Part No.	LENGTH in (mm)	GRATE INTAKE sq in (sq cm)
37492	27.55 (700)	21.33 (137.7)
37493	31.50 (800)	25.10 (162.0)
37494	35.43 (900)	28.85 (186.2)
37495	39.37 (1000)	31.36 (202.4)
37496	47.25 (1200)	36.37 (234.7)
37497	55.12 (1400)	41.38 (267.0)
37498	59.05 (1500)	45.05 (290.6)

Part No.	LENGTH in (mm)	GRATE INTAKE sq in (sq cm)
37541	27.55 (700)	21.33 (137.7)
37542	31.50 (800)	25.10 (162.0)
37543	35.43 (900)	28.85 (186.2)
37544	39.37 (1000)	31.36 (202.4)
37545	47.25 (1200)	36.37 (234.7)
37546	55.12 (1400)	41.38 (267.0)
37547	59.05 (1500)	45.05 (290.6)



**Matte
Black**

CLASSIC FINISH



Oil-Rubbed
Bronze

LUXURY FINISH

Part No.	LENGTH in (mm)	GRATE INTAKE sq in (sq cm)
37611	27.55 (700)	21.33 (137.7)
37612	31.50 (800)	25.10 (162.0)
37613	35.43 (900)	28.85 (186.2)
37614	39.37 (1000)	31.36 (202.4)
37615	47.25 (1200)	36.37 (234.7)
37616	55.12 (1400)	41.38 (267.0)
37617	59.05 (1500)	45.05 (290.6)

Part No.	LENGTH in (mm)	GRATE INTAKE sq in (sq cm)
37669	27.55 (700)	21.33 (137.7)
37670	31.50 (800)	25.10 (162.0)
37671	35.43 (900)	28.85 (186.2)
37672	39.37 (1000)	31.36 (202.4)
37673	47.25 (1200)	36.37 (234.7)
37674	55.12 (1400)	41.38 (267.0)
37675	59.05 (1500)	45.05 (290.6)



Satin
Brass

LUXURY FINISH



Rose
Gold

LUXURY FINISH

Part No.	LENGTH in (mm)	GRATE INTAKE sq in (sq cm)
37741	27.55 (700)	21.33 (137.7)
37742	31.50 (800)	25.10 (162.0)
37743	35.43 (900)	28.85 (186.2)
37744	39.37 (1000)	31.36 (202.4)
37745	47.25 (1200)	36.37 (234.7)
37746	55.12 (1400)	41.38 (267.0)
37747	59.05 (1500)	45.05 (290.6)

Part No.	LENGTH in (mm)	GRATE INTAKE sq in (sq cm)
37811	27.55 (700)	21.33 (137.7)
37812	31.50 (800)	25.10 (162.0)
37813	35.43 (900)	28.85 (186.2)
37814	39.37 (1000)	31.36 (202.4)
37815	47.25 (1200)	36.37 (234.7)
37816	55.12 (1400)	41.38 (267.0)
37817	59.05 (1500)	45.05 (290.6)



Black
Nickel

LUXURY FINISH

Hawaii



SLOT SIZE
0.28" (7 mm) max width

Polished Chrome



Part No.	LENGTH in (mm)	GRATE INTAKE sq in (sq cm)
37499	27.55 (700)	15.73 (101.5)
37500	31.50 (800)	17.48 (112.8)
37501	35.43 (900)	19.22 (124.0)
37502	39.37 (1000)	22.72 (146.6)
37503	47.25 (1200)	26.22 (169.2)
37504	55.12 (1400)	29.72 (191.8)
37505	59.05 (1500)	35.14 (226.7)



**Polished
Chrome**

CLASSIC FINISH



**Brushed
Stainless**

CLASSIC FINISH

Part No.	LENGTH in (mm)	GRATE INTAKE sq in (sq cm)
37398	27.55 (700)	15.73 (101.5)
37399	31.50 (800)	17.48 (112.8)
37400	35.43 (900)	19.22 (124.0)
37401	39.37 (1000)	22.72 (146.6)
37402	47.25 (1200)	26.22 (169.2)
37414	55.12 (1400)	29.72 (191.8)
37384	59.05 (1500)	35.14 (226.7)

Part No.	LENGTH in (mm)	GRATE INTAKE sq in (sq cm)
37548	27.55 (700)	15.73 (101.5)
37549	31.50 (800)	17.48 (112.8)
37550	35.43 (900)	19.22 (124.0)
37551	39.37 (1000)	22.72 (146.6)
37552	47.25 (1200)	26.22 (169.2)
37553	55.12 (1400)	29.72 (191.8)
37554	59.05 (1500)	35.14 (226.7)



**Matte
Black**

CLASSIC FINISH

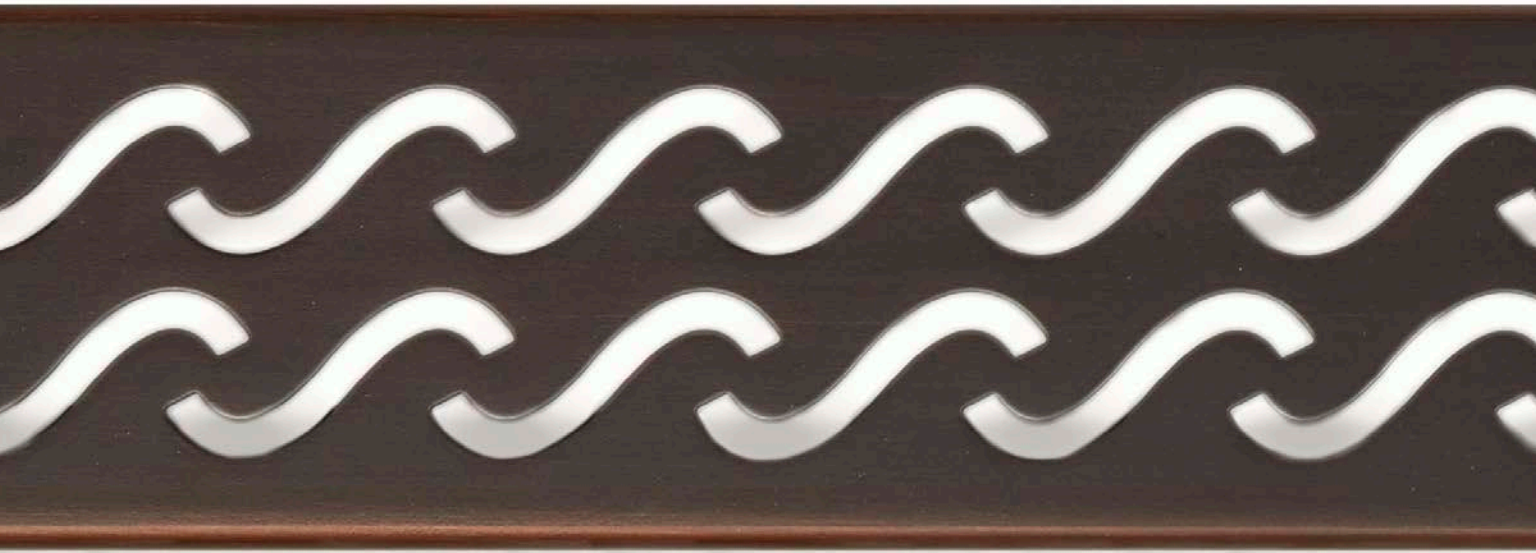

Oil-Rubbed
Bronze

LUXURY FINISH

Part No.	LENGTH in (mm)	GRATE INTAKE sq in (sq cm)
37618	27.55 (700)	15.73 (101.5)
37619	31.50 (800)	17.48 (112.8)
37620	35.43 (900)	19.22 (124.0)
37621	39.37 (1000)	22.72 (146.6)
37622	47.25 (1200)	26.22 (169.2)
37623	55.12 (1400)	29.72 (191.8)
37624	59.05 (1500)	35.14 (226.7)

Part No.	LENGTH in (mm)	GRATE INTAKE sq in (sq cm)
37676	27.55 (700)	15.73 (101.5)
37677	31.50 (800)	17.48 (112.8)
37678	35.43 (900)	19.22 (124.0)
37679	39.37 (1000)	22.72 (146.6)
37680	47.25 (1200)	26.22 (169.2)
37681	55.12 (1400)	29.72 (191.8)
37682	59.05 (1500)	35.14 (226.7)



Satin
Brass

LUXURY FINISH

Part No.	LENGTH in (mm)	GRATE INTAKE sq in (sq cm)
37748	27.55 (700)	15.73 (101.5)
37749	31.50 (800)	17.48 (112.8)
37750	35.43 (900)	19.22 (124.0)
37751	39.37 (1000)	22.72 (146.6)
37752	47.25 (1200)	26.22 (169.2)
37753	55.12 (1400)	29.72 (191.8)
37754	59.05 (1500)	35.14 (226.7)

Rose
Gold

LUXURY FINISH

Part No.	LENGTH in (mm)	GRATE INTAKE sq in (sq cm)
37818	27.55 (700)	15.73 (101.5)
37819	31.50 (800)	17.48 (112.8)
37820	35.43 (900)	19.22 (124.0)
37821	39.37 (1000)	22.72 (146.6)
37822	47.25 (1200)	26.22 (169.2)
37823	55.12 (1400)	29.72 (191.8)
37824	59.05 (1500)	35.14 (226.7)



Black
Nickel

LUXURY FINISH

Linear

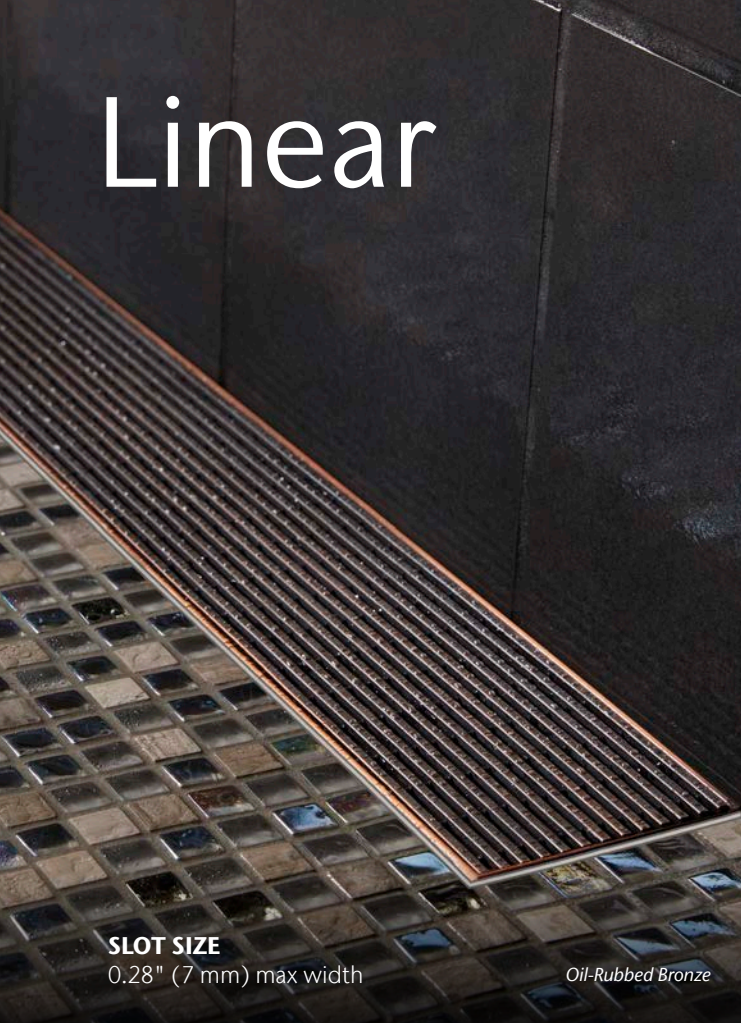

SLOT SIZE
0.28" (7 mm) max width

Oil-Rubbed Bronze

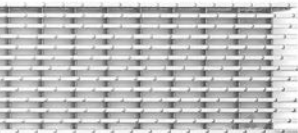
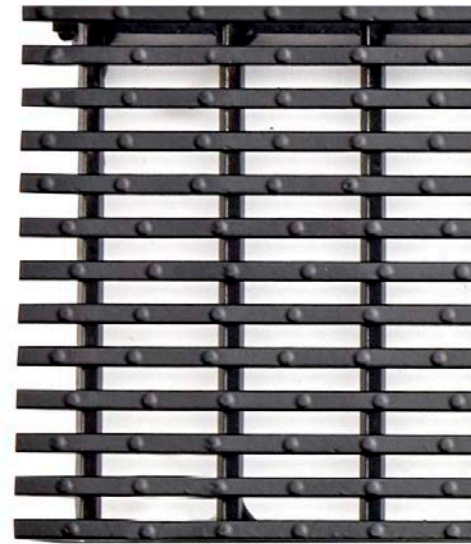

**Brushed
Stainless**

CLASSIC FINISH

Part No.	LENGTH in (mm)	GRATE INTAKE sq in (sq cm)
37420	27.55 (700)	21.33 (137.7)
37421	31.50 (800)	25.10 (162.0)
37422	35.43 (900)	28.85 (186.2)
37423	39.37 (1000)	31.36 (202.4)
37424	47.25 (1200)	36.37 (234.7)
37425	55.12 (1400)	41.38 (267.0)

Part No.	LENGTH in (mm)	GRATE INTAKE sq in (sq cm)
37583	27.55 (700)	21.33 (137.7)
37584	31.50 (800)	25.10 (162.0)
37585	35.43 (900)	28.85 (186.2)
37586	39.37 (1000)	31.36 (202.4)
37587	47.25 (1200)	36.37 (234.7)
37588	55.12 (1400)	41.38 (267.0)



**Matte
Black**

CLASSIC FINISH

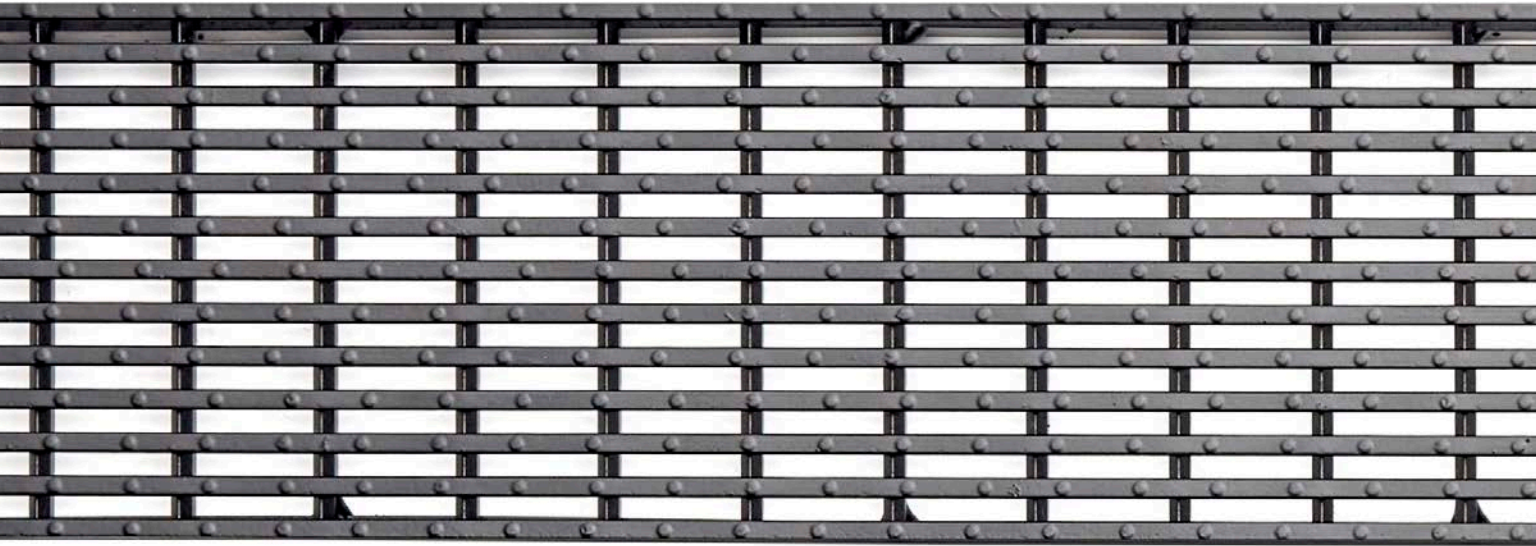

Oil-Rubbed
Bronze

LUXURY FINISH

Part No.	LENGTH in (mm)	GRATE INTAKE sq in (sq cm)
37647	27.55 (700)	21.33 (137.7)
37648	31.50 (800)	25.10 (162.0)
37649	35.43 (900)	28.85 (186.2)
37650	39.37 (1000)	31.36 (202.4)
37651	47.25 (1200)	36.37 (234.7)
37652	55.12 (1400)	41.38 (267.0)

Part No.	LENGTH in (mm)	GRATE INTAKE sq in (sq cm)
37711	27.55 (700)	21.33 (137.7)
37712	31.50 (800)	25.10 (162.0)
37713	35.43 (900)	28.85 (186.2)
37714	39.37 (1000)	31.36 (202.4)
37715	47.25 (1200)	36.37 (234.7)
37716	55.12 (1400)	41.38 (267.0)



Satin
Brass

LUXURY FINISH



Rose
Gold

LUXURY FINISH

Part No.	LENGTH in (mm)	GRATE INTAKE sq in (sq cm)
37783	27.55 (700)	21.33 (137.7)
37784	31.50 (800)	25.10 (162.0)
37785	35.43 (900)	28.85 (186.2)
37786	39.37 (1000)	31.36 (202.4)
37787	47.25 (1200)	36.37 (234.7)
37788	55.12 (1400)	41.38 (267.0)

Part No.	LENGTH in (mm)	GRATE INTAKE sq in (sq cm)
37853	27.55 (700)	21.33 (137.7)
37854	31.50 (800)	25.10 (162.0)
37855	35.43 (900)	28.85 (186.2)
37856	39.37 (1000)	31.36 (202.4)
37857	47.25 (1200)	36.37 (234.7)
37858	55.12 (1400)	41.38 (267.0)



Black
Nickel

LUXURY FINISH

Mix



SLOT SIZE
0.28" (7 mm) max width

Matte Black



**Brushed
Stainless**

CLASSIC FINISH

Part No.	LENGTH in (mm)	GRATE INTAKE sq in (sq cm)
37403	27.55 (700)	18.54 (119.7)
37404	31.50 (800)	20.88 (134.8)
37405	35.43 (900)	23.56 (152.0)
37406	39.37 (1000)	26.47 (170.8)
37407	47.25 (1200)	27.72 (178.8)
37415	55.12 (1400)	28.95 (186.8)
37385	59.05 (1500)	39.10 (252.2)



**Polished
Chrome**

CLASSIC FINISH

Part No.	LENGTH in (mm)	GRATE INTAKE sq in (sq cm)
37506	27.55 (700)	18.54 (119.7)
37507	31.50 (800)	20.88 (134.8)
37508	35.43 (900)	23.56 (152.0)
37509	39.37 (1000)	26.47 (170.8)
37510	47.25 (1200)	27.72 (178.8)
37511	55.12 (1400)	28.95 (186.8)
37512	59.05 (1500)	39.10 (252.2)

Part No.	LENGTH in (mm)	GRATE INTAKE sq in (sq cm)
37555	27.55 (700)	18.54 (119.7)
37556	31.50 (800)	20.88 (134.8)
37557	35.43 (900)	23.56 (152.0)
37558	39.37 (1000)	26.47 (170.8)
37559	47.25 (1200)	27.72 (178.8)
37560	55.12 (1400)	28.95 (186.8)
37561	59.05 (1500)	39.10 (252.2)



**Matte
Black**

CLASSIC FINISH

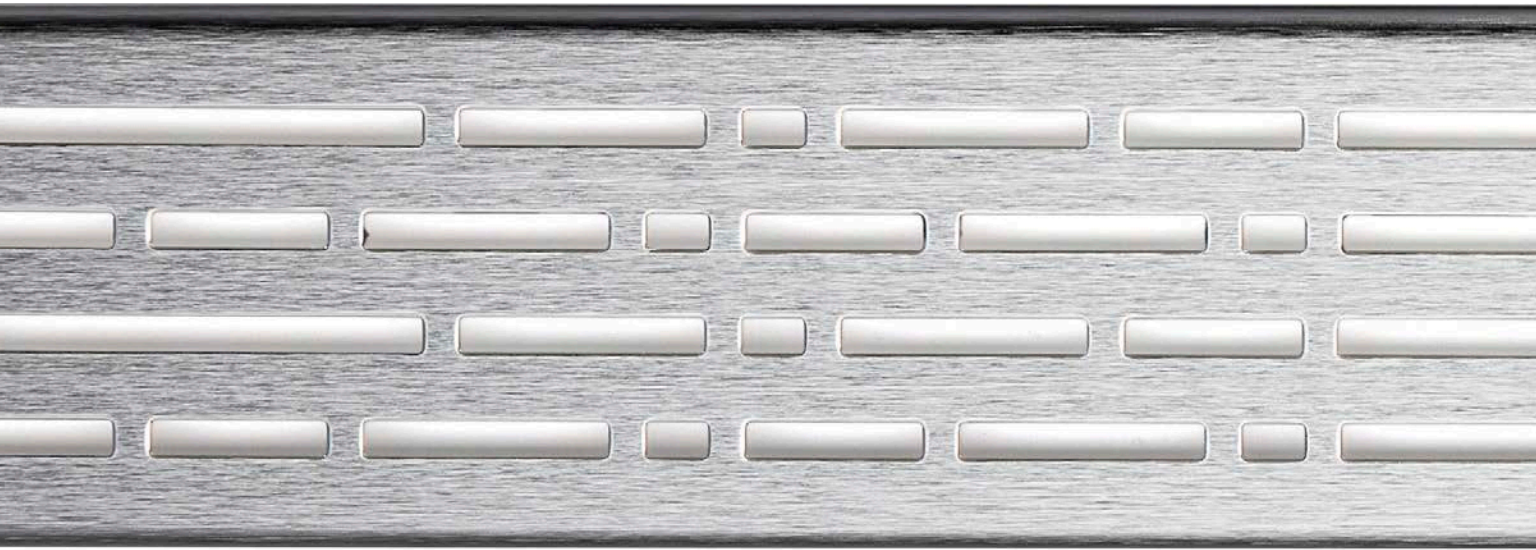

Oil-Rubbed
Bronze

LUXURY FINISH

Part No.	LENGTH in (mm)	GRATE INTAKE sq in (sq cm)
37625	27.55 (700)	18.54 (119.7)
37626	31.50 (800)	20.88 (134.8)
37627	35.43 (900)	23.56 (152.0)
37628	39.37 (1000)	26.47 (170.8)
37629	47.25 (1200)	27.72 (178.8)
37630	55.12 (1400)	28.95 (186.8)
37631	59.05 (1500)	39.10 (252.2)

Part No.	LENGTH in (mm)	GRATE INTAKE sq in (sq cm)
37683	27.55 (700)	18.54 (119.7)
37684	31.50 (800)	20.88 (134.8)
37685	35.43 (900)	23.56 (152.0)
37686	39.37 (1000)	26.47 (170.8)
37687	47.25 (1200)	27.72 (178.8)
37688	55.12 (1400)	28.95 (186.8)
37689	59.05 (1500)	39.10 (252.2)



Satin
Brass

LUXURY FINISH



Rose
Gold

LUXURY FINISH

Part No.	LENGTH in (mm)	GRATE INTAKE sq in (sq cm)
37755	27.55 (700)	18.54 (119.7)
37756	31.50 (800)	20.88 (134.8)
37757	35.43 (900)	23.56 (152.0)
37758	39.37 (1000)	26.47 (170.8)
37759	47.25 (1200)	27.72 (178.8)
37760	55.12 (1400)	28.95 (186.8)
37761	59.05 (1500)	39.10 (252.2)

Part No.	LENGTH in (mm)	GRATE INTAKE sq in (sq cm)
37825	27.55 (700)	18.54 (119.7)
37826	31.50 (800)	20.88 (134.8)
37827	35.43 (900)	23.56 (152.0)
37828	39.37 (1000)	26.47 (170.8)
37829	47.25 (1200)	27.72 (178.8)
37830	55.12 (1400)	28.95 (186.8)
37831	59.05 (1500)	39.10 (252.2)



Black
Nickel

LUXURY FINISH

Piano

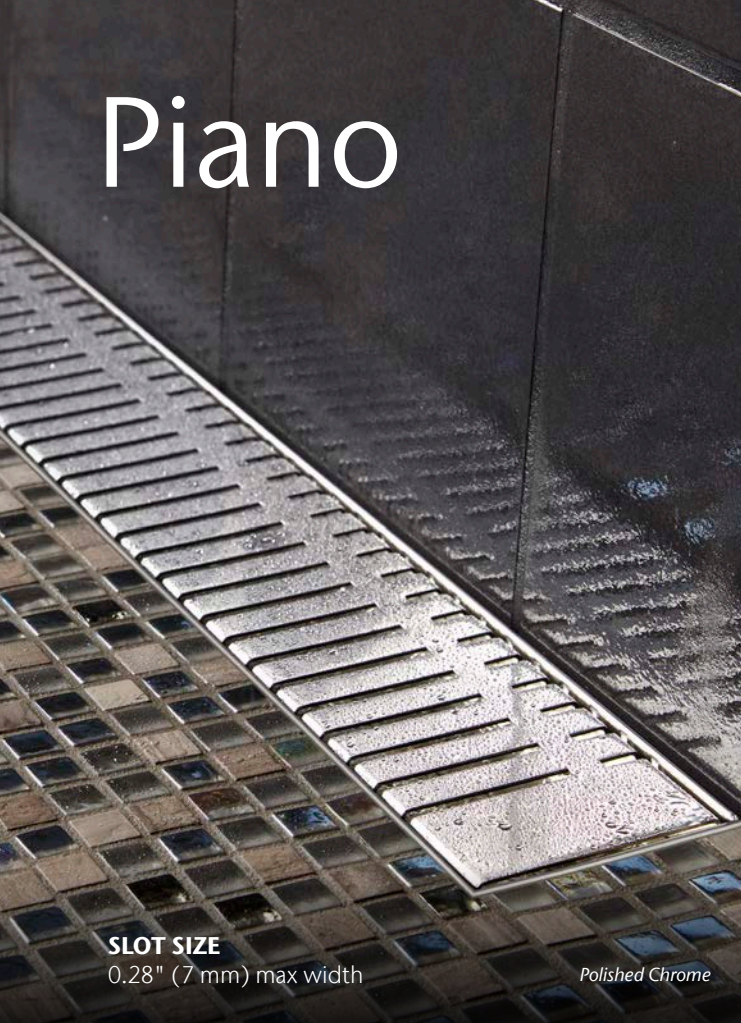

SLOT SIZE
0.28" (7 mm) max width

Polished Chrome



**Brushed
Stainless**

CLASSIC FINISH

Part No.	LENGTH in (mm)	GRATE INTAKE sq in (sq cm)
37450	27.55 (700)	16.62 (107.2)
37451	31.50 (800)	19.11 (123.3)
37452	35.43 (900)	21.60 (139.4)
37453	39.37 (1000)	24.09 (155.4)
37454	47.25 (1200)	29.08 (187.6)
37455	55.12 (1400)	34.89 (225.1)
37386	59.05 (1500)	35.19 (227.1)



**Polished
Chrome**

CLASSIC FINISH

Part No.	LENGTH in (mm)	GRATE INTAKE sq in (sq cm)
37513	27.55 (700)	16.62 (107.2)
37514	31.50 (800)	19.11 (123.3)
37515	35.43 (900)	21.60 (139.4)
37516	39.37 (1000)	24.09 (155.4)
37517	47.25 (1200)	29.08 (187.6)
37518	55.12 (1400)	34.89 (225.1)
37519	59.05 (1500)	35.19 (227.1)

Part No.	LENGTH in (mm)	GRATE INTAKE sq in (sq cm)
37562	27.55 (700)	16.62 (107.2)
37563	31.50 (800)	19.11 (123.3)
37564	35.43 (900)	21.60 (139.4)
37565	39.37 (1000)	24.09 (155.4)
37566	47.25 (1200)	29.08 (187.6)
37567	55.12 (1400)	34.89 (225.1)
37568	59.05 (1500)	35.19 (227.1)



**Matte
Black**

CLASSIC FINISH



Oil-Rubbed
Bronze

LUXURY FINISH

Part No.	LENGTH in (mm)	GRATE INTAKE sq in (sq cm)
37632	27.55 (700)	16.62 (107.2)
37633	31.50 (800)	19.11 (123.3)
37634	35.43 (900)	21.60 (139.4)
37635	39.37 (1000)	24.09 (155.4)
37636	47.25 (1200)	29.08 (187.6)
37637	55.12 (1400)	34.89 (225.1)
37638	59.05 (1500)	35.19 (227.1)

Part No.	LENGTH in (mm)	GRATE INTAKE sq in (sq cm)
37690	27.55 (700)	16.62 (107.2)
37691	31.50 (800)	19.11 (123.3)
37692	35.43 (900)	21.60 (139.4)
37693	39.37 (1000)	24.09 (155.4)
37694	47.25 (1200)	29.08 (187.6)
37695	55.12 (1400)	34.89 (225.1)
37696	59.05 (1500)	35.19 (227.1)



Satin
Brass

LUXURY FINISH



Rose
Gold

LUXURY FINISH

Part No.	LENGTH in (mm)	GRATE INTAKE sq in (sq cm)
37762	27.55 (700)	16.62 (107.2)
37763	31.50 (800)	19.11 (123.3)
37764	35.43 (900)	21.60 (139.4)
37765	39.37 (1000)	24.09 (155.4)
37766	47.25 (1200)	29.08 (187.6)
37767	55.12 (1400)	34.89 (225.1)
37768	59.05 (1500)	35.19 (227.1)

Part No.	LENGTH in (mm)	GRATE INTAKE sq in (sq cm)
37832	27.55 (700)	16.62 (107.2)
37833	31.50 (800)	19.11 (123.3)
37834	35.43 (900)	21.60 (139.4)
37835	39.37 (1000)	24.09 (155.4)
37836	47.25 (1200)	29.08 (187.6)
37837	55.12 (1400)	34.89 (225.1)
37838	59.05 (1500)	35.19 (227.1)



Black
Nickel

LUXURY FINISH

Quadrato



SLOT SIZE
0.28" (7 mm) max width

Brushed Stainless

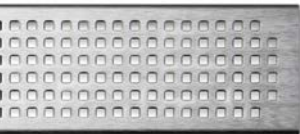

**Brushed
Stainless**

CLASSIC FINISH

Part No.	LENGTH in (mm)	GRATE INTAKE sq in (sq cm)
37359	27.55 (700)	15.39 (99.3)
37360	31.50 (800)	17.71 (114.3)
37361	35.43 (900)	20.02 (129.3)
37362	39.37 (1000)	22.35 (144.2)
37363	47.25 (1200)	26.68 (172.2)
37418	55.12 (1400)	31.01 (200.1)
37390	59.05 (1500)	34.26 (221.0)

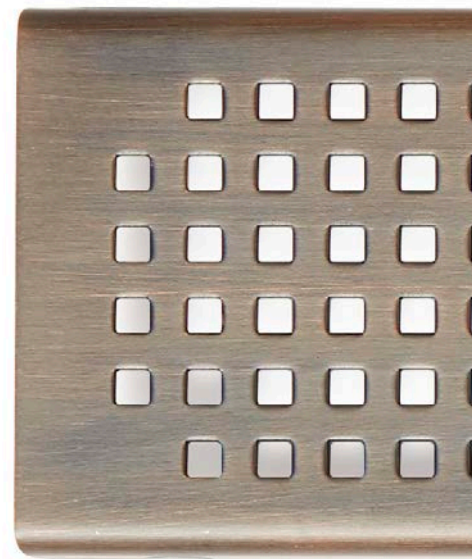

**Polished
Chrome**

CLASSIC FINISH



**Matte
Black**

CLASSIC FINISH

Part No.	LENGTH in (mm)	GRATE INTAKE sq in (sq cm)
37520	27.55 (700)	15.39 (99.3)
37521	31.50 (800)	17.71 (114.3)
37522	35.43 (900)	20.02 (129.3)
37523	39.37 (1000)	22.35 (144.2)
37524	47.25 (1200)	26.68 (172.2)
37525	55.12 (1400)	31.01 (200.1)
37526	59.05 (1500)	34.26 (221.0)

Part No.	LENGTH in (mm)	GRATE INTAKE sq in (sq cm)
37569	27.55 (700)	15.39 (99.3)
37570	31.50 (800)	17.71 (114.3)
37571	35.43 (900)	20.02 (129.3)
37572	39.37 (1000)	22.35 (144.2)
37573	47.25 (1200)	26.68 (172.2)
37574	55.12 (1400)	31.01 (200.1)
37575	59.05 (1500)	34.26 (221.0)

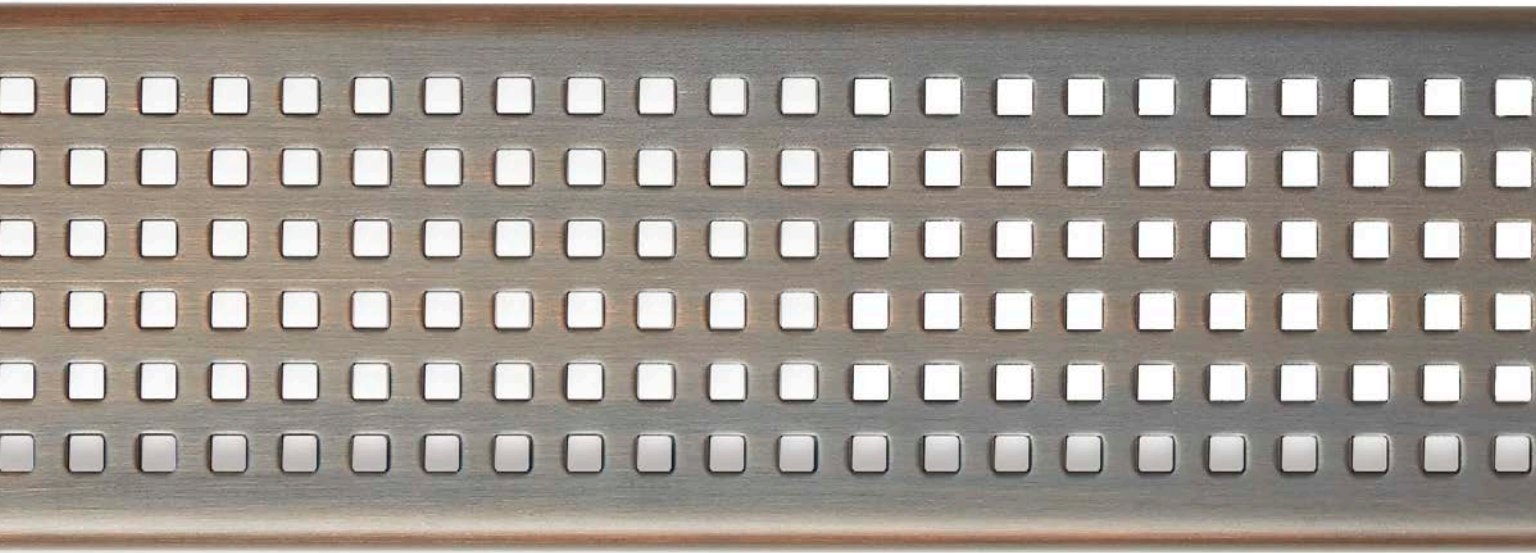

Oil-Rubbed
Bronze

LUXURY FINISH

Part No.	LENGTH in (mm)	GRATE INTAKE sq in (sq cm)
37317	27.55 (700)	15.39 (99.3)
37639	31.50 (800)	17.71 (114.3)
37303	35.43 (900)	20.02 (129.3)
37640	39.37 (1000)	22.35 (144.2)
37307	47.25 (1200)	26.68 (172.2)
37641	55.12 (1400)	31.01 (200.1)
37642	59.05 (1500)	34.26 (221.0)

Part No.	LENGTH in (mm)	GRATE INTAKE sq in (sq cm)
37697	27.55 (700)	15.39 (99.3)
37698	31.50 (800)	17.71 (114.3)
37699	35.43 (900)	20.02 (129.3)
37700	39.37 (1000)	22.35 (144.2)
37701	47.25 (1200)	26.68 (172.2)
37702	55.12 (1400)	31.01 (200.1)
37703	59.05 (1500)	34.26 (221.0)



Satin
Brass

LUXURY FINISH

Part No.	LENGTH in (mm)	GRATE INTAKE sq in (sq cm)
37769	27.55 (700)	15.39 (99.3)
37770	31.50 (800)	17.71 (114.3)
37771	35.43 (900)	20.02 (129.3)
37772	39.37 (1000)	22.35 (144.2)
37773	47.25 (1200)	26.68 (172.2)
37774	55.12 (1400)	31.01 (200.1)
37775	59.05 (1500)	34.26 (221.0)

Rose
Gold

LUXURY FINISH

Part No.	LENGTH in (mm)	GRATE INTAKE sq in (sq cm)
37839	27.55 (700)	15.39 (99.3)
37840	31.50 (800)	17.71 (114.3)
37841	35.43 (900)	20.02 (129.3)
37842	39.37 (1000)	22.35 (144.2)
37843	47.25 (1200)	26.68 (172.2)
37844	55.12 (1400)	31.01 (200.1)
37845	59.05 (1500)	34.26 (221.0)



Black
Nickel

LUXURY FINISH

Solid



SLOT SIZE
0.28" (7 mm) max width

Polished Chrome

Part No.	LENGTH in (mm)	GRATE INTAKE sq in (sq cm)
37534	27.55 (700)	15.39 (99.3)
37535	31.50 (800)	17.71 (114.3)
37536	35.43 (900)	20.03 (129.3)
37537	39.37 (1000)	22.35 (144.2)
37538	47.25 (1200)	26.68 (172.2)
37539	55.12 (1400)	31.01 (200.1)
37540	59.05 (1500)	33.35 (215.1)



**Polished
Chrome**

CLASSIC FINISH

Part No.	LENGTH in (mm)	GRATE INTAKE sq in (sq cm)
37476	27.55 (700)	15.39 (99.3)
37477	31.50 (800)	17.71 (114.3)
37478	35.43 (900)	20.03 (129.3)
37479	39.37 (1000)	22.35 (144.2)
37480	47.25 (1200)	26.68 (172.2)
37481	55.12 (1400)	31.01 (200.1)
37393	59.05 (1500)	33.35 (215.1)

**Brushed
Stainless**

CLASSIC FINISH

Part No.	LENGTH in (mm)	GRATE INTAKE sq in (sq cm)
37590	27.55 (700)	15.39 (99.3)
37591	31.50 (800)	17.71 (114.3)
37592	35.43 (900)	20.03 (129.3)
37593	39.37 (1000)	22.35 (144.2)
37594	47.25 (1200)	26.68 (172.2)
37595	55.12 (1400)	31.01 (200.1)
37596	59.05 (1500)	33.35 (215.1)



**Matte
Black**

CLASSIC FINISH



Oil-Rubbed
Bronze

LUXURY FINISH

Part No.	LENGTH in (mm)	GRATE INTAKE sq in (sq cm)
37654	27.55 (700)	15.39 (99.3)
37655	31.50 (800)	17.71 (114.3)
37656	35.43 (900)	20.03 (129.3)
37657	39.37 (1000)	22.35 (144.2)
37658	47.25 (1200)	26.68 (172.2)
37659	55.12 (1400)	31.01 (200.1)
37660	59.05 (1500)	33.35 (215.1)

Part No.	LENGTH in (mm)	GRATE INTAKE sq in (sq cm)
37718	27.55 (700)	15.39 (99.3)
37719	31.50 (800)	17.71 (114.3)
37720	35.43 (900)	20.03 (129.3)
37721	39.37 (1000)	22.35 (144.2)
37722	47.25 (1200)	26.68 (172.2)
37723	55.12 (1400)	31.01 (200.1)
37724	59.05 (1500)	33.35 (215.1)



Satin
Brass

LUXURY FINISH



Rose
Gold

LUXURY FINISH

Part No.	LENGTH in (mm)	GRATE INTAKE sq in (sq cm)
37790	27.55 (700)	15.39 (99.3)
37791	31.50 (800)	17.71 (114.3)
37792	35.43 (900)	20.03 (129.3)
37793	39.37 (1000)	22.35 (144.2)
37794	47.25 (1200)	26.68 (172.2)
37795	55.12 (1400)	31.01 (200.1)
37796	59.05 (1500)	33.35 (215.1)

Part No.	LENGTH in (mm)	GRATE INTAKE sq in (sq cm)
37860	27.55 (700)	15.39 (99.3)
37861	31.50 (800)	17.71 (114.3)
37862	35.43 (900)	20.03 (129.3)
37863	39.37 (1000)	22.35 (144.2)
37864	47.25 (1200)	26.68 (172.2)
37865	55.12 (1400)	31.01 (200.1)
37866	59.05 (1500)	33.35 (215.1)



Black
Nickel

LUXURY FINISH

Tile-In

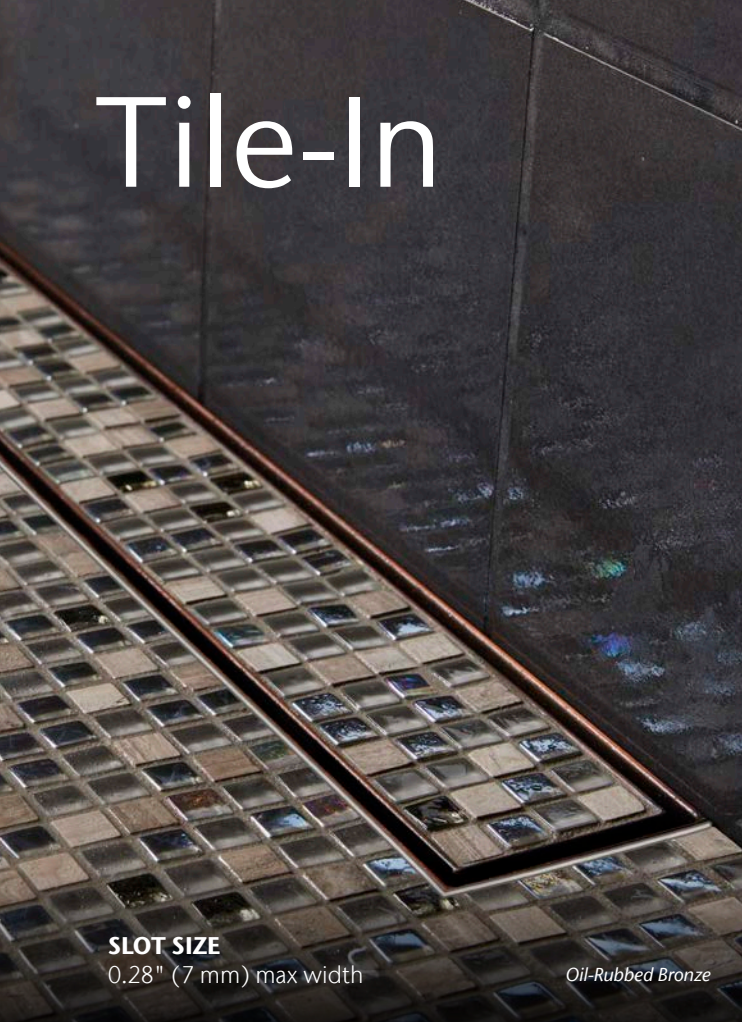

SLOT SIZE
0.28" (7 mm) max width

Oil-Rubbed Bronze



**Brushed
Stainless**

CLASSIC FINISH

Part No.	LENGTH in (mm)	GRATE INTAKE sq in (sq cm)
37335	27.55 (700)	13.66 (88.2)
37338	31.50 (800)	15.57 (100.5)
37336	35.43 (900)	17.48 (112.8)
37334	39.37 (1000)	19.39 (125.1)
37332	47.25 (1200)	23.20 (149.7)
37419	55.12 (1400)	27.01 (174.3)
37394	59.05 (1500)	26.59 (171.6)

Part No.	LENGTH in (mm)	GRATE INTAKE sq in (sq cm)
37597	27.55 (700)	13.66 (88.2)
37598	31.50 (800)	15.57 (100.5)
37599	35.43 (900)	17.48 (112.8)
37600	39.37 (1000)	19.39 (125.1)
37601	47.25 (1200)	23.20 (149.7)
37602	55.12 (1400)	27.01 (174.3)
37603	59.05 (1500)	26.59 (171.6)



**Matte
Black**

CLASSIC FINISH



Oil-Rubbed
Bronze

LUXURY FINISH

Part No.	LENGTH in (mm)	GRATE INTAKE sq in (sq cm)
37327	27.55 (700)	13.66 (88.2)
37661	31.50 (800)	15.57 (100.5)
37331	35.43 (900)	17.48 (112.8)
37662	39.37 (1000)	19.39 (125.1)
37310	47.25 (1200)	23.20 (149.7)
37663	55.12 (1400)	27.01 (174.3)
37664	59.05 (1500)	26.59 (171.6)

Part No.	LENGTH in (mm)	GRATE INTAKE sq in (sq cm)
37725	27.55 (700)	13.66 (88.2)
37726	31.50 (800)	15.57 (100.5)
37727	35.43 (900)	17.48 (112.8)
37728	39.37 (1000)	19.39 (125.1)
37729	47.25 (1200)	23.20 (149.7)
37730	55.12 (1400)	27.01 (174.3)
37731	59.05 (1500)	26.59 (171.6)



Satin
Brass

LUXURY FINISH



Rose
Gold

LUXURY FINISH

Part No.	LENGTH in (mm)	GRATE INTAKE sq in (sq cm)
37797	27.55 (700)	13.66 (88.2)
37798	31.50 (800)	15.57 (100.5)
37799	35.43 (900)	17.48 (112.8)
37800	39.37 (1000)	19.39 (125.1)
37801	47.25 (1200)	23.20 (149.7)
37802	55.12 (1400)	27.01 (174.3)
37803	59.05 (1500)	26.59 (171.6)

Part No.	LENGTH in (mm)	GRATE INTAKE sq in (sq cm)
37867	27.55 (700)	13.66 (88.2)
37868	31.50 (800)	15.57 (100.5)
37869	35.43 (900)	17.48 (112.8)
37870	39.37 (1000)	19.39 (125.1)
37871	47.25 (1200)	23.20 (149.7)
37872	55.12 (1400)	27.01 (174.3)
37873	59.05 (1500)	26.59 (171.6)



Black
Nickel

LUXURY FINISH

Wave

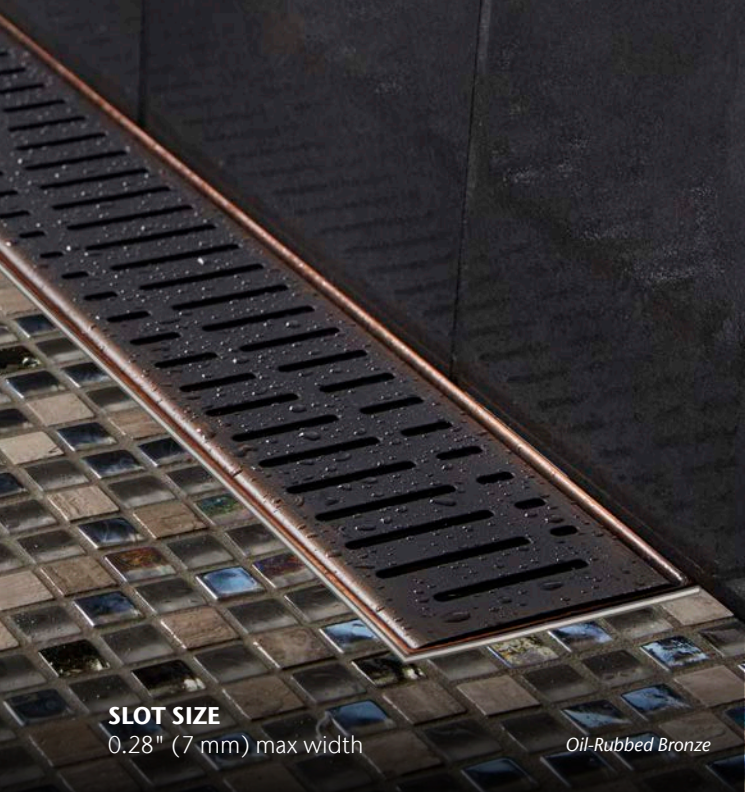

SLOT SIZE
0.28" (7 mm) max width

Oil-Rubbed Bronze



**Brushed
Stainless**

CLASSIC FINISH

Part No.	LENGTH in (mm)	GRATE INTAKE sq in (sq cm)
37342	27.55 (700)	13.66 (88.2)
37343	31.50 (800)	15.57 (100.5)
37344	35.43 (900)	17.48 (112.8)
37345	39.37 (1000)	19.39 (125.1)
37346	47.25 (1200)	23.20 (149.7)
37413	55.12 (1400)	27.01 (174.3)
37391	59.05 (1500)	31.33 (202.2)

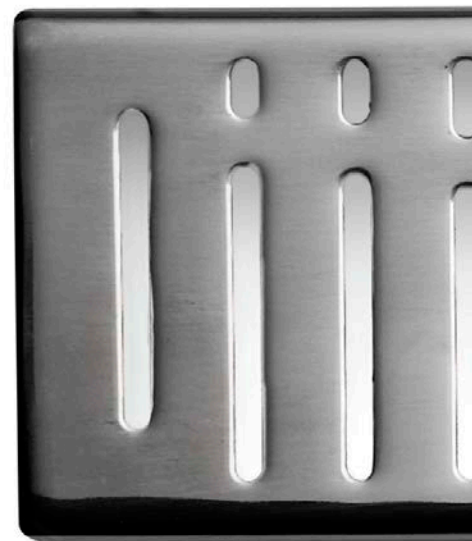

**Polished
Chrome**

CLASSIC FINISH

Part No.	LENGTH in (mm)	GRATE INTAKE sq in (sq cm)
37527	27.55 (700)	13.66 (88.2)
37528	31.50 (800)	15.57 (100.5)
37529	35.43 (900)	17.48 (112.8)
37530	39.37 (1000)	19.39 (125.1)
37531	47.25 (1200)	23.20 (149.7)
37532	55.12 (1400)	27.01 (174.3)
37533	59.05 (1500)	31.33 (202.2)

Part No.	LENGTH in (mm)	GRATE INTAKE sq in (sq cm)
37576	27.55 (700)	13.66 (88.2)
37577	31.50 (800)	15.57 (100.5)
37578	35.43 (900)	17.48 (112.8)
37579	39.37 (1000)	19.39 (125.1)
37580	47.25 (1200)	23.20 (149.7)
37581	55.12 (1400)	27.01 (174.3)
37582	59.05 (1500)	31.33 (202.2)



**Matte
Black**

CLASSIC FINISH

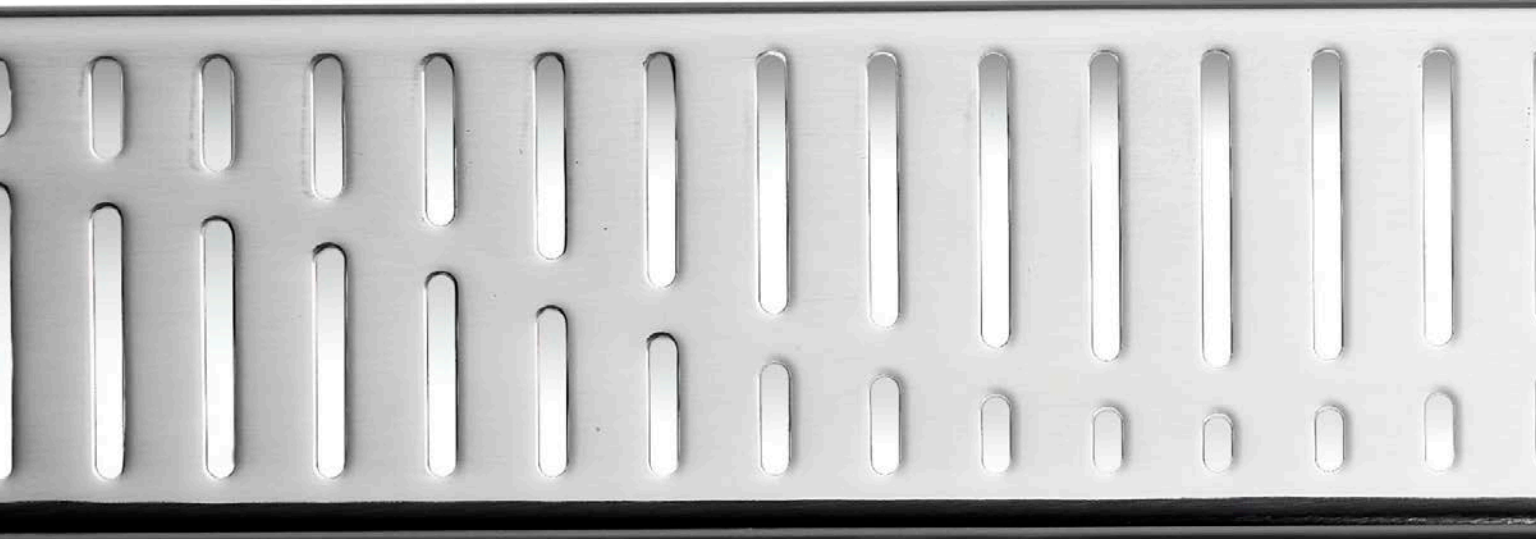

Oil-Rubbed
Bronze

LUXURY FINISH



Rose
Gold

LUXURY FINISH

Part No.	LENGTH in (mm)	GRATE INTAKE sq in (sq cm)
37312	27.55 (700)	13.66 (88.2)
37643	31.50 (800)	15.57 (100.5)
37308	35.43 (900)	17.48 (112.8)
37644	39.37 (1000)	19.39 (125.1)
37302	47.25 (1200)	23.20 (149.7)
37645	55.12 (1400)	27.01 (174.3)
37646	59.05 (1500)	31.33 (202.2)

Part No.	LENGTH in (mm)	GRATE INTAKE sq in (sq cm)
37776	27.55 (700)	13.66 (88.2)
37777	31.50 (800)	15.57 (100.5)
37778	35.43 (900)	17.48 (112.8)
37779	39.37 (1000)	19.39 (125.1)
37780	47.25 (1200)	23.20 (149.7)
37781	55.12 (1400)	27.01 (174.3)
37782	59.05 (1500)	31.33 (202.2)

Part No.	LENGTH in (mm)	GRATE INTAKE sq in (sq cm)
37704	27.55 (700)	13.66 (88.2)
37705	31.50 (800)	15.57 (100.5)
37706	35.43 (900)	17.48 (112.8)
37707	39.37 (1000)	19.39 (125.1)
37708	47.25 (1200)	23.20 (149.7)
37709	55.12 (1400)	27.01 (174.3)
37710	59.05 (1500)	31.33 (202.2)

Part No.	LENGTH in (mm)	GRATE INTAKE sq in (sq cm)
37846	27.55 (700)	13.66 (88.2)
37847	31.50 (800)	15.57 (100.5)
37848	35.43 (900)	17.48 (112.8)
37849	39.37 (1000)	19.39 (125.1)
37850	47.25 (1200)	23.20 (149.7)
37851	55.12 (1400)	27.01 (174.3)
37852	59.05 (1500)	31.33 (202.2)



Satin
Brass

LUXURY FINISH



Black
Nickel

LUXURY FINISH





Plain Edge Channel Options

Plain Edge - Center Outlet

For use when the drain pipe is centered.

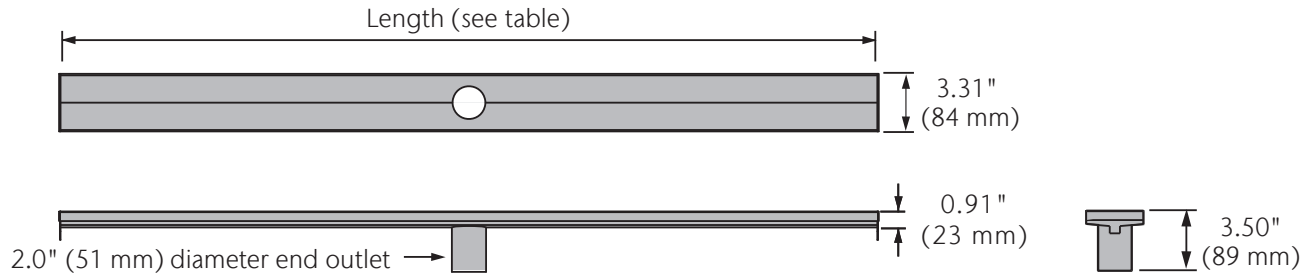

	Part No.	LENGTH in (mm)	
Brushed Stainless	93861	27.55 (700)	
	93864	31.50 (800)	
	CLASSIC FINISH	93865	35.43 (900)
	93869	39.37 (1000)	
	93872	47.25 (1200)	
	93816	55.12 (1400)	
	37395	59.05 (1500)	

	Part No.	LENGTH in (mm)	
Matte Black	37604	27.55 (700)	
	37605	31.50 (800)	
	CLASSIC FINISH	37606	35.43 (900)
	37607	39.37 (1000)	
	37608	47.25 (1200)	
	37609	55.12 (1400)	
	37610	59.05 (1500)	

	Part No.	LENGTH in (mm)	
Oil-Rubbed Bronze	93180	27.55 (700)	
	37665	31.50 (800)	
	LUXURY FINISH	93184	35.43 (900)
	37666	39.37 (1000)	
	93182	47.25 (1200)	
	37667	55.12 (1400)	
	37668	59.05 (1500)	

	Part No.	LENGTH in (mm)	
Satin Brass	37732	27.55 (700)	
	37733	31.50 (800)	
	LUXURY FINISH	37734	35.43 (900)
	37735	39.37 (1000)	
	37736	47.25 (1200)	
	37737	55.12 (1400)	
	37738	59.05 (1500)	

	Part No.	LENGTH in (mm)	
Rose Gold	37804	27.55 (700)	
	37805	31.50 (800)	
	LUXURY FINISH	37806	35.43 (900)
	37807	39.37 (1000)	
	37808	47.25 (1200)	
	37809	55.12 (1400)	
	37810	59.05 (1500)	

	Part No.	LENGTH in (mm)	
Black Nickel	37874	27.55 (700)	
	37875	31.50 (800)	
	LUXURY FINISH	37876	35.43 (900)
	37877	39.37 (1000)	
	37878	47.25 (1200)	
	37879	55.12 (1400)	
	37880	59.05 (1500)	

Plain Edge - End Outlet

To avoid construction beams and easy use for bathtub remodels.

	Part No.	LENGTH in (mm)	
Brushed Stainless	91877	27.55 (700)	
	91878	31.50 (800)	
	CLASSIC FINISH	91879	35.43 (900)
	91880	39.37 (1000)	
	91881	47.25 (1200)	
	91882	55.12 (1400)	

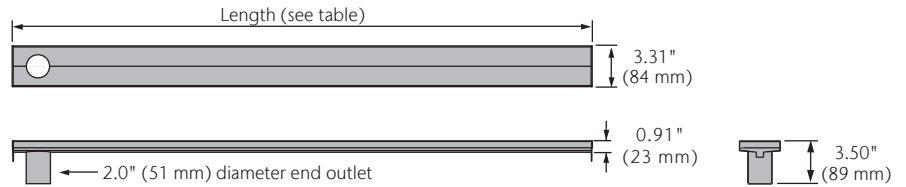

Plain Edge - Offset Outlet

To avoid construction beams.

	Part No.	LENGTH in (mm)	
Brushed Stainless	92226	27.55 (700)	
	92225	31.50 (800)	
	CLASSIC FINISH	92224	35.43 (900)
	92223	39.37 (1000)	

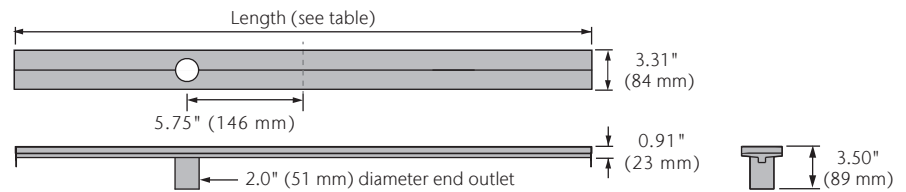

Flange Edge Channel Options

Weeping Flange Edge Channel - Center Outlet

Unique preassembled flange edge with fixed fabric membrane and weep holes for secondary drainage.

Brushed Stainless	
Part No.	LENGTH in (mm)
92179	27.55 (700)
92180	31.50 (800)
CLASSIC FINISH	
92181	35.43 (900)
92182	39.37 (1000)
92183	47.25 (1200)
92184	55.12 (1400)

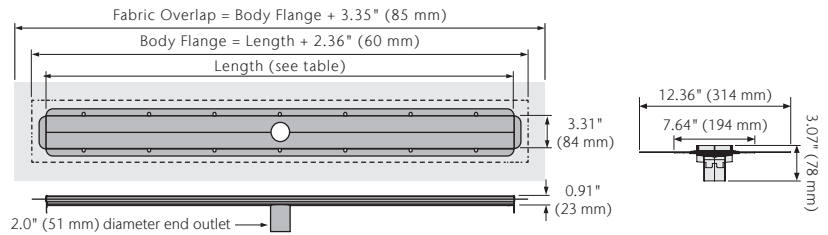

Flange Edge Channel - Center Outlet

Preassembled stainless steel flange for optimum connection of a compound seal.

Brushed Stainless	
Part No.	LENGTH in (mm)
93866	27.55 (700)
93873	31.50 (800)
CLASSIC FINISH	
93862	35.43 (900)
93870	39.37 (1000)
93875	47.25 (1200)
93817	55.12 (1400)

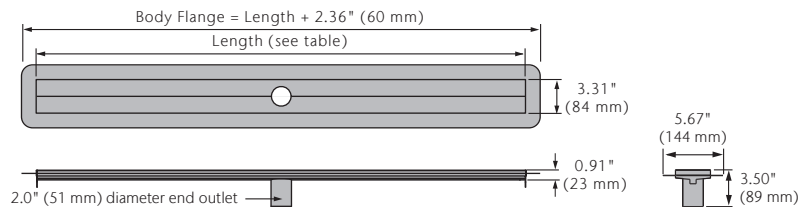



Premium

Custom Solutions

For projects where standard-sized channels are not suitable, customization is available to ensure the unit meets required performance criteria.

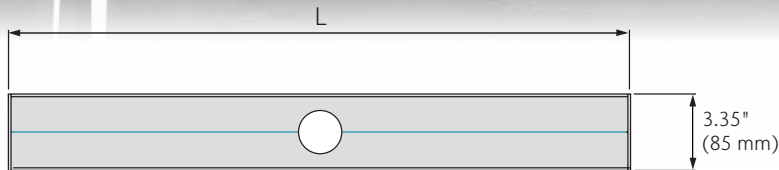

Length L = inches (mm) Width fixed at 3.35" (85 mm)

Note: For flange body overall width is 5.67" (144 mm); Overall length is L + 2.36" (60 mm).

1. Length of Shower Channel

To meet specific room requirements, the channel can be manufactured to specific length requirements - minimum 27.55" (700 mm) and 10' (3048 mm). Standard length grates are used; this may result in multiple grates per channel.

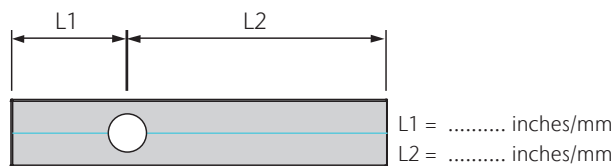

Custom position

L1 = inches/mm

L2 = inches/mm

2. Position of 2.0" (51 mm) Outlet

Plumbing layout restrictions may require a non-standard outlet position - the position of the outlet can be manufactured to accommodate site requirements.

Horizontal placement of standard 2.0" (51 mm) outlet is also available.

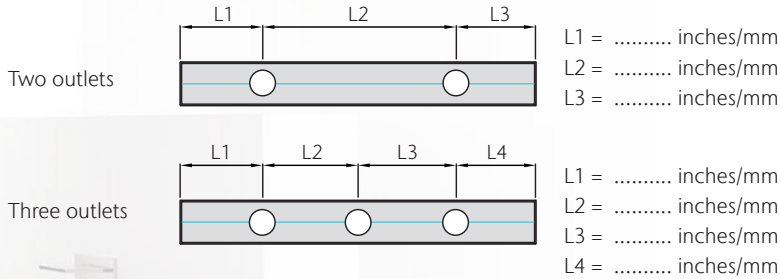

Notes:

- All diagrams show plain edge shower channel body
- Custom features are also available on flange edge shower channel bodies
- Custom channels are only available in polished finish
- Solid Grates may be customized with custom lettering and are only available in a polished finish

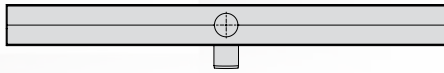

4. Threaded 2.0" NPT Outlet

A male threaded outlet can be manufactured on the underside of the body for direct screw attachment to piping.



5. Built-In Side Outlet

Where plumbing codes allow built in traps with horizontal outlets.

Premium

ShowerPoint

The Art of Luxury

Even a singular point can be given style. ACO Premium brings quality, elegance and design to the traditional point drain. Each grate style will come packaged with a plastic shallow drain body. Tile-In body is stainless steel.

Hawaii



BODY	DESCRIPTION	LENGTH in (mm)	GRATE INTAKE sq in (sq cm)	Part No.
Shallow	Non-locking	5.83 (148)	6.2 (40.0)	37456
Deep	Non-locking	5.83 (148)	6.2 (40.0)	37223

SLOT SIZE 0.28" (7 mm) max width

Mix



BODY	DESCRIPTION	LENGTH in (mm)	GRATE INTAKE sq in (sq cm)	Part No.
Shallow	Non-locking	5.83 (148)	6.7 (43.3)	37457
Deep	Non-locking	5.83 (148)	6.7 (43.3)	37222

SLOT SIZE 0.16" (4 mm) max width

Quadrato



BODY	DESCRIPTION	LENGTH in (mm)	GRATE INTAKE sq in (sq cm)	Part No.
Shallow	Non-locking	5.83 (148)	4.5 (29.1)	37458
Deep	Non-locking	5.83 (148)	4.5 (29.1)	37225

SLOT SIZE 0.16" (4 mm) max width

Wave



BODY	DESCRIPTION	LENGTH in (mm)	GRATE INTAKE sq in (sq cm)	Part No.
Shallow	Non-locking	5.83 (148)	9.3 (60.0)	37459
Deep	Non-locking	5.83 (148)	9.3 (60.0)	37221

SLOT SIZE 0.16" (4 mm) max width

Includes:

- ShowerDrain body - chrome plated
ABS body with stainless steel trim
- Stainless Grate
- 2" Threaded Coupler



Tile-In*



BODY	DESCRIPTION	LENGTH in (mm)	GRATE INTAKE sq in (sq cm)	Part No.
Tile-In	Non-locking	5.91 (150)	5.0 (32.3)	37229

SLOT SIZE 0.16" (4 mm) max width

* Tile tray and stainless steel drain body are packaged as a set.

ShowerPoint Body Options

Plastic Shallow Drain Body

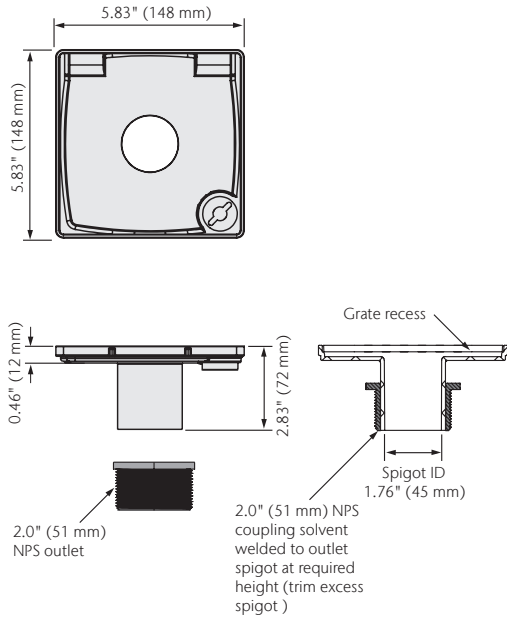

Stainless Steel Tile-In Drain Body & Tray

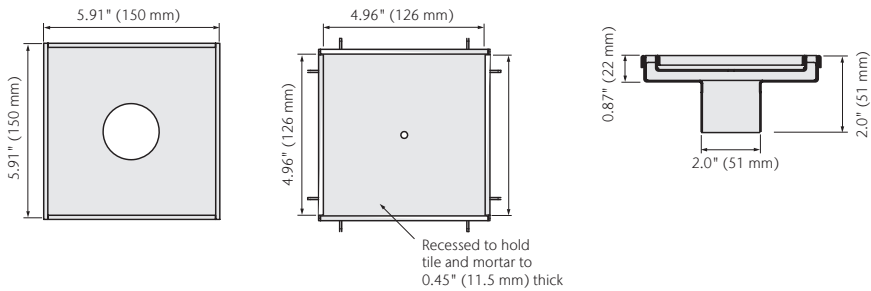

Accessories



PVC Drain Flange - Typically used with **plain body channel**. Allows connection and clamping of either a fabric or CPE flexible membrane with a compression fit. Connects to channel spigot with the aid of a compression gasket.

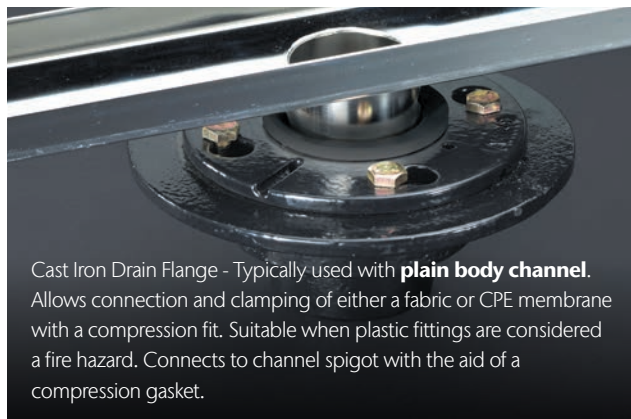

Cast Iron Drain Flange - Typically used with **plain body channel**. Allows connection and clamping of either a fabric or CPE membrane with a compression fit. Suitable when plastic fittings are considered a fire hazard. Connects to channel spigot with the aid of a compression gasket.



Stainless Steel Clad Coupling - Typically used with **flange edge channel**, where a fabric or painted membrane is applied directly to the flange of the channel. Stainless steel makes it suitable where plastic fittings are considered a fire hazard.



Debris Strainer - Sits inside the 2.0" diameter outlet to collect hair and debris. Note use of strainer will reduce flow performance of shower channel.

DESCRIPTION	Part No.
Debris Strainer - Polished Steel	37381
Debris Strainer - Oil-Rubbed Bronze	37382
PVC Drain Flange	93871

DESCRIPTION	Part No.
Cast Iron Drain Flange	93808
Compression Gasket	93785
Stainless Steel Clad Coupling	93874

ACO ShowerChannel Technical Information

Hydraulic Performance

Accumulation & Slopes

ASME A112.6.3-2001 requires a 2.0" outlet for shower applications.

ACO ShowerChannel drains have this as standard. The flow value for a 2.0" outlet varies depending upon the head of water above the grate. In the case of shower channels, a head of water is not typical in practice. Area drains can have a head of water due to the 'basin' profile of floor grades. Flow values without any accumulation (head of water) should be used when shower channels are placed around the perimeter of the shower and no shower threshold step is used.

If the channel is installed against a wall or in a valley (2-way slope), there may be a small amount of water accumulation depending on the shower layout. The grade of shower floor will determine the depth of build-up.

Outflow Performance

The choice of shower channel generally depends on the flow values of the shower fitting. 70% of shower heads have a maximum capacity of less than 3 GPM.

The ACO ShowerDrain standard channel has an outflow up to **11.90 GPM**. This value assumes no head of water above drain.

EN1253: when a drain is against a wall, it is allowable to have up to **0.75" (20 mm)** of water above the drain.

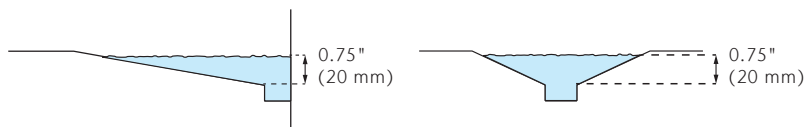

ACO ShowerChannel Planning & Considerations

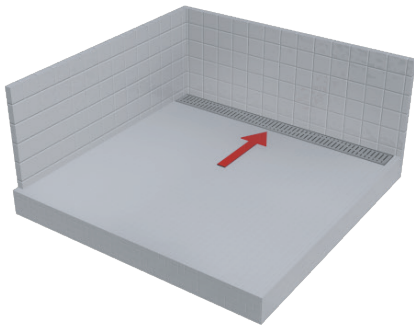

Installation Against the Wall

Simple slope solution in one direction

- Slope away from the bathroom dry area
- No risk of bypass

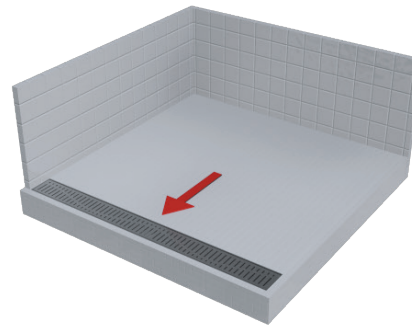

Installation at Shower Entrance

Slope in one direction, lowest at the shower entrance

- Possible risk of bypass
- Slope of bathroom floor towards shower area is recommended to prevent bypass
- Channel length should exactly fit the shower width and/or opening

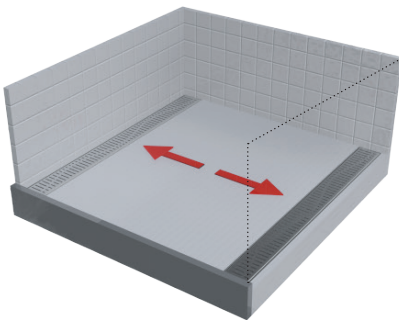

Installation With Two Channels

Two directional slope

- Ideal for very large shower areas
- Can be used with barrier step

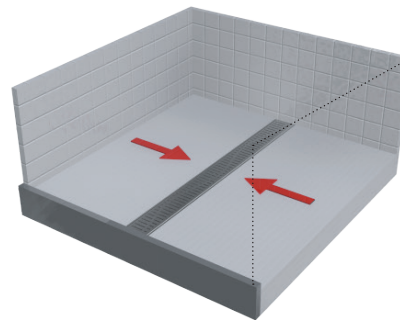

Installation With Center Channel

Two-directional slope towards the channel

- Whole bathroom floor or just shower area can be sloped towards channel
- Can be used with barrier step

ACO ShowerPoint Technical Information

Hydraulic Performance

Accumulation & Slopes

ASME A112.6.3-2001 requires a 2.0" outlet for shower applications.

ACO ShowerPoint drains have this as standard. The flow value for a 2.0" outlet varies depending upon the head of water above the grate. Flow values with no or minimal accumulation (head of water) should be used when shower drain is placed within the general bathroom floor area.

If the shower drain is installed within the shower stall, there will be a head of water due to 'basin' profile of floor grades; amount of accumulation (head of water) will vary depending on the layout of the shower area. The floor within the shower can be created with a higher gradient and/or the shower may have a lip which will increase accumulation (head of water).

Outflow Performance

The choice of shower drain generally depends on the flow values of the shower fitting. 70% of shower heads have a maximum capacity of less than 3 GPM.

The 6" ACO ShowerPoint drain unit has an outflow of up to **13.5 GPM** and the 4" ACO ShowerPoint drain unit has an outflow of up to **9.0 GPM**. This value assumes a 0.6" (15 mm) head of water above the drain.

Based upon these flow rates, ACO ShowerPoint drains can be used in conjunction with the majority of shower head fittings.





ACO ShowerPoint Planning & Considerations

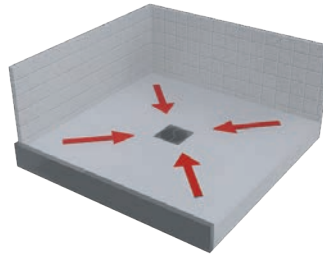

ShowerPoint Within Shower Area

With a single ShowerPoint drain, floors must be graded appropriately or other barriers must be used to prevent flow of water into bathroom area.

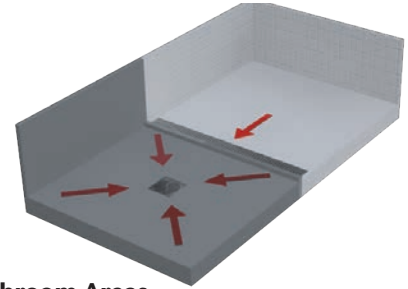

ShowerPoint Within Shower and Bathroom Areas

Multiple ShowerPoint drains can be positioned within both the shower and bathroom areas. ShowerPoint can be used as a secondary drainage point outside of the shower stall. Bathroom area ShowerPoint will also drain any spills or leaks from cleaning or other bathroom fixtures.

ACO ShowerDrain

Premium Grate Visualizer

Let us help you create your dream bathroom with the brand-new ACO ShowerDrain Visualizer. Make ordering simple by downloading your results, including spec sheets. Choose from 6 different tile options, a variety of grate patterns and modern finishes!

Installation Preview

- 2 Drain Positions
- 6 Bathroom Designs
- 9 Premium Grates
- 7 Grate Finishes





Train

Information
and Education

Global expertise with architects,
engineers, installers and
distributors who value quality.

Design

Planning
and Optimization

Experience to lead you towards
the most efficient drainage
solution for your budget.

Support

Advice
and Presence

Experts available to assist you
during project planning and
implementation stages.

Care

Inspection
and Maintenance

After-sales support to ensure
that ACO will exceed your
standards for years to come.

Have a question? **ask**ACO has the answer!

www.acobd.com

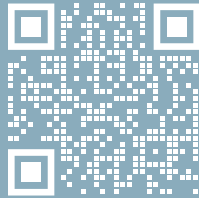

ACO. we care for water

West Sales Office
825 W. Beechcraft St.
Casa Grande, AZ 85122

Tel: (520) 421-9988
Toll-Free: (888) 490-9552
Fax: (520) 421-9899

info@acousa.com

© October 2024 ACO, Inc.

All reasonable care has been taken in compiling the information in this document. All recommendations and suggestions on the use of ACO products are made without guarantee since the conditions of use are beyond the control of the company. It is the customer's responsibility to ensure that each product is fit for its intended purpose and that the actual conditions of use are suitable. ACO, Inc. reserves the right to change products and specifications without notice.

SDP_CAT_001

